



Wide Angle Reflecting Target for Robotic Total Station ZERO220 PLUS Instruction Manual

ZERO220 PLUS is a wide angle reflecting target especially designed for robotic total station. Surrounded 5 prisms catch and reflect the laser signal widely. Also, it can be used with 9mm diameter pole as prism constant 0.

● Package Contents

- ZERO220 PLUS
- Soft Storage Case
- Instruction Manual
- Adaptor for Prism Pole (MAG50)
- Protection Fabric Band for Prism
- Shoe for MAG50 (DMP-M6)
- Hex Wrench

● Name of Parts

- ZERO220 PLUS
- Collimation Target (Type2)
- Collimation Target (Type1)

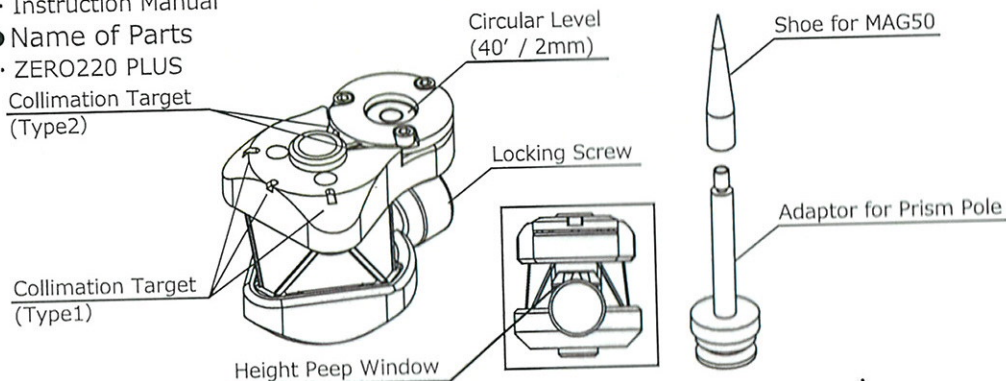

● Specifications

ZERO220 PLUS

Model	:Z-220P
Dimension	:45 (W) x 65 (D) x 50 (H) mm
Weight	:196g
Compatible Pole	:φ 9 mm DM Pole
Operating Range	:Vertical Direction 30° Horizontal Direction 220° (Ref. "Operating Range")
Prism Constant	:0mm
Circular Level	:40' / 2mm

※For a precision surveying, please oppose Collimation Target to Total Station.

Adaptor for Prism pole

Model	:MAG50
Pole Length	:60mm
Pole Diameter	:φ 9mm
Weight	:90g
Screw	:5/8 inch Female M6 Male

Shoe for MAG50

Model	:DMP-M6
Length	:50mm
Diameter	:φ 9mm
Weight	:10g
Screw	:M6 Female

● Prism Height

ZERO220 PLUS

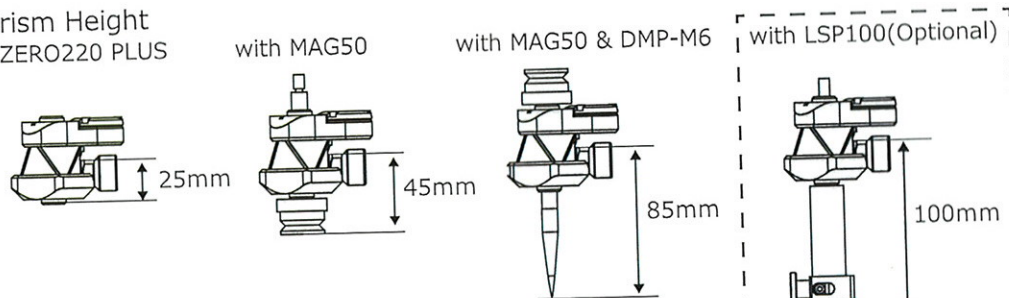

※For mounting to Leica Spigot, please use an optional accessory; SPIGOT TYPE POLE ADAPTER (LSP100).

● Operating Range

Fig.1

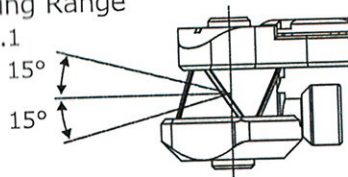
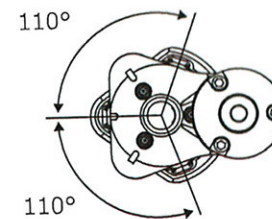

Fig.2



● Position of Collimation Target

For a precision surveying, please oppose Collimation Target to Total Station.

There are 2 types of Collimation Target. Collimation Target is different depending on your Total Station. Please confirm your type by the following instruction.

1. Set up ZERO220 PLUS about 5M apart from the instrument.
 2. Place ZERO220 PLUS at the height of Total Station.
 3. Start measuring by AUTO TRACKING mode.
 4. Please peep and check type of Collimation Target through a telescope.
 5. If you can see the prism as shown in Fig.A, it's Type1.
If you can see the prism as shown in Fig.B, it's Type2.
- ※ If your instrument doesn't have AUTO TRACKING mode, it's Type1.

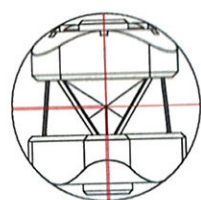

Fig.A

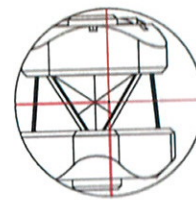
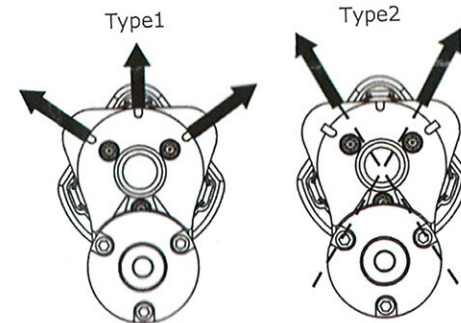

Fig.B

※The above figures show the reticle in red.



● Caution

- Be sure to check damage before use.
- Do not have a shock and vibration.
- Be careful with sharp edge of prism in case the prism breaks.
- Prism unit can be repaired. To get better performance please contact us if you have damaged prism.
- If product get wet, please fully dehydrate before using or putting in soft case.
- Adapter for prism pole has sharp point. Please handle carefully.
- Be sure to keep clean the prism surface.
- Do not decompose and remodel it.
- It is necessary to note that this product does not correspond to all Total Stations.

● Disclaimer

- 1) The user of this product is expected to follow the instruction manual and make periodic checks of the products performance.
- 2) The manufacturer, or its representatives, assumes no responsibility for results of a faulty or intentional usage or misuse including any direct, indirect, consequential damage, and loss of profits.
- 3) The manufacturer, or its representatives, assumes no responsibility for consequential damage, and loss of profits by any disaster; (an earthquake, storms, floods etc.).
A fire, accident, or an act of a third party and/or a usage any other usual conditions.
- 4) The manufacturer, or its representatives, assumes no responsibility for any damage, and loss of profits due to a change of data, loss of data, an interruption of business etc., caused by using the product or an unusable product.
- 5) The manufacturer, or its representatives, assumes no responsibility for any damage, and loss of profits caused by usage except for explained in the instruction manual.
- 6) The manufacturer, or its representatives, assumes no responsibility for damage caused by wrong movement, or action due to connecting with other products.

Myzox Co., Ltd.

401 Yamagoe, Nagakute, Aichi 480-1111 Japan

TEL : +81-561-64-2210 FAX : +81-561-63-7770

www.myzoxjapan.com